

$$1 \times 10$$

10x Representation Cards

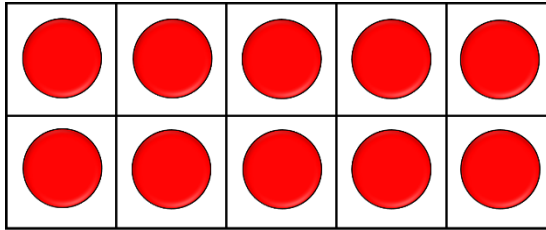

10x Representation Cards

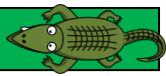
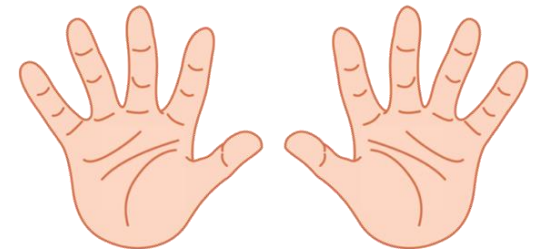
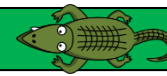

10x Representation Cards

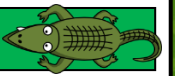

1 group of
10

10x Representation Cards

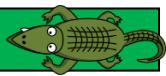

10

10x Representation Cards

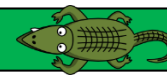

10x Representation Cards



$$2 \times 10$$

10x Representation Cards

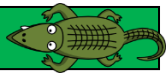

$$10 \times 2$$

10x Representation Cards

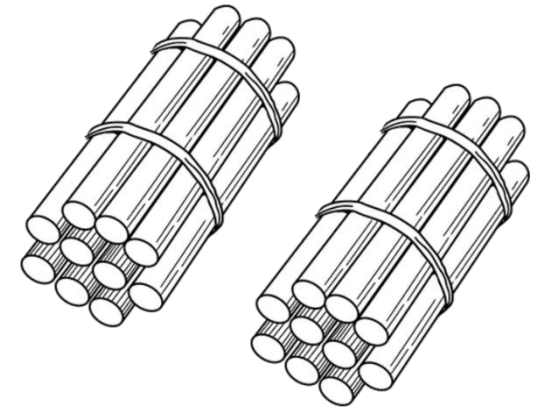
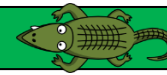

10x Representation Cards

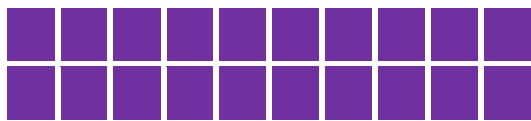
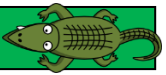

10x Representation Cards

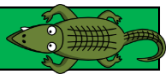

20

10x Representation Cards

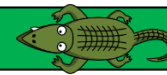

2 multiplied
by 10

10x Representation Cards

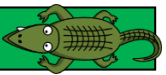

$$3 \times 10$$

10x Representation Cards

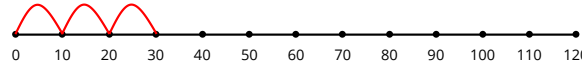
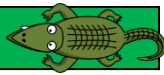

10x Representation Cards

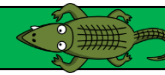

10x Representation Cards



$$10 + 10 + 10$$

10x Representation Cards

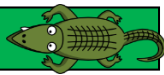

30

10x Representation Cards

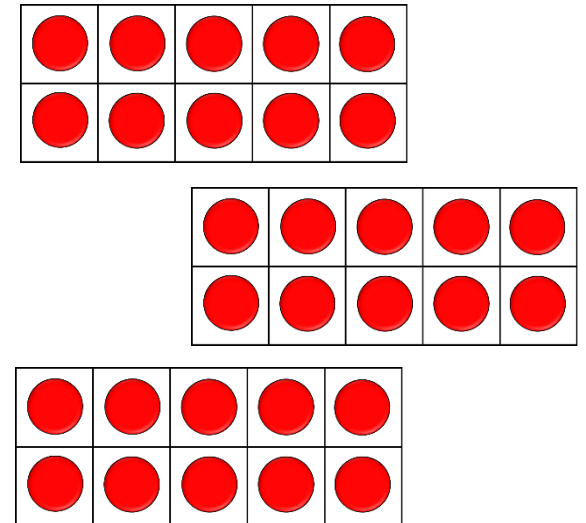
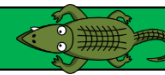

10x Representation Cards



$$4 \times 10$$

10x Representation Cards

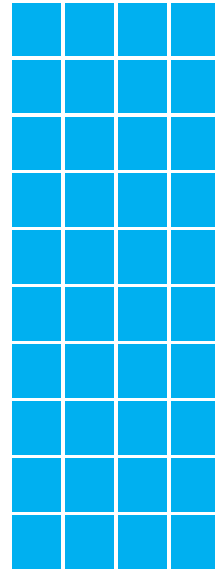
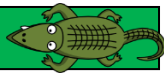

10x Representation Cards

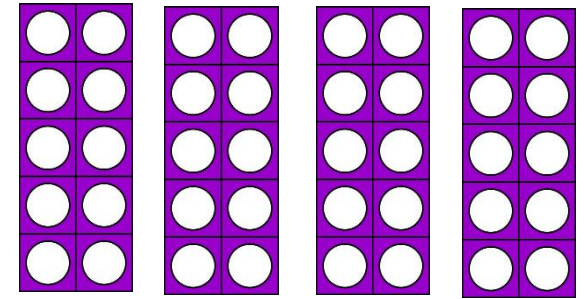
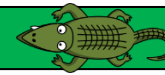

10x Representation Cards



4 groups of
10

10x Representation Cards

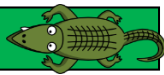

40

10x Representation Cards

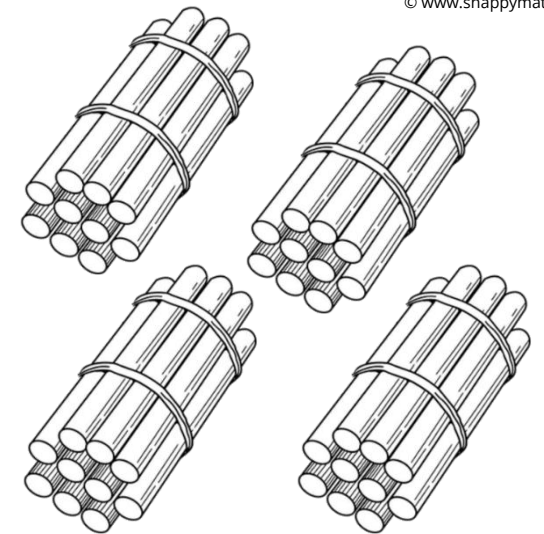
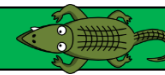

10x Representation Cards



$$5 \times 10$$

10x Representation Cards

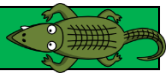

$$10 \times 5$$

10x Representation Cards

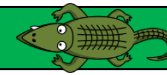

10x Representation Cards

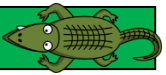

$$10+10+10+10+10$$

10x Representation Cards

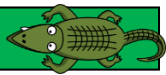

50

10x Representation Cards

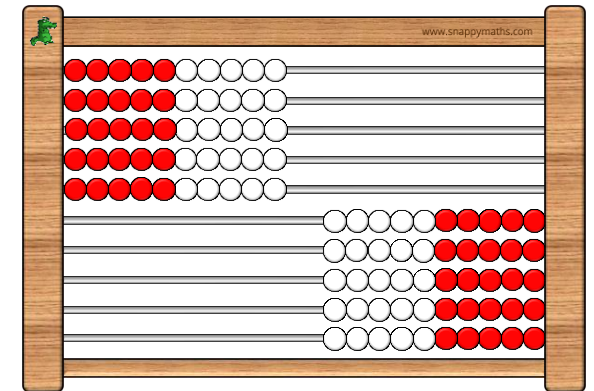
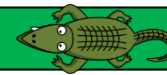

10x Representation Cards

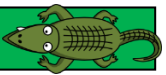

$$6 \times 10$$

10x Representation Cards

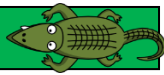

10x Representation Cards

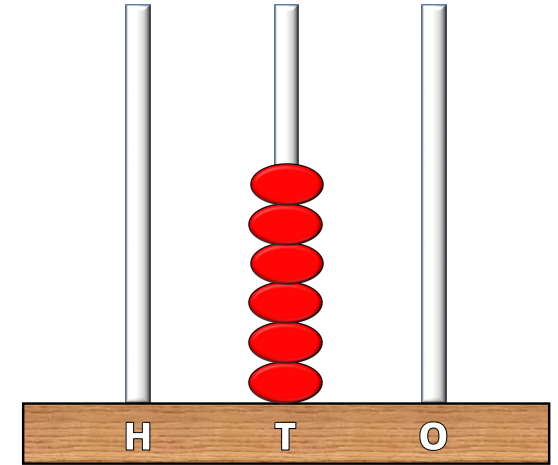
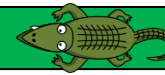

10x Representation Cards



6 groups
of 10

10x Representation Cards

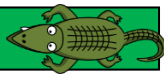

60

10x Representation Cards

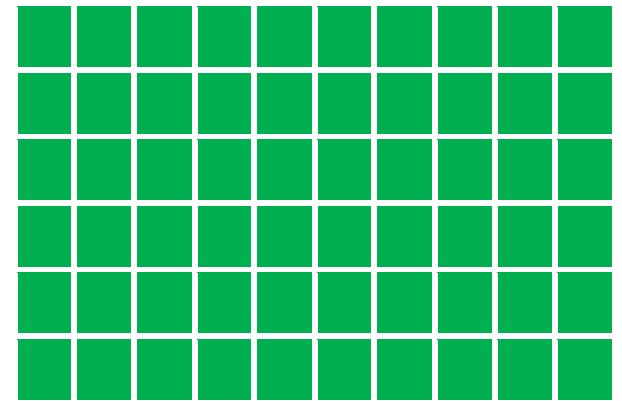
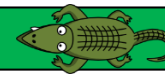

10x Representation Cards



$$7 \times 10$$

10x Representation Cards

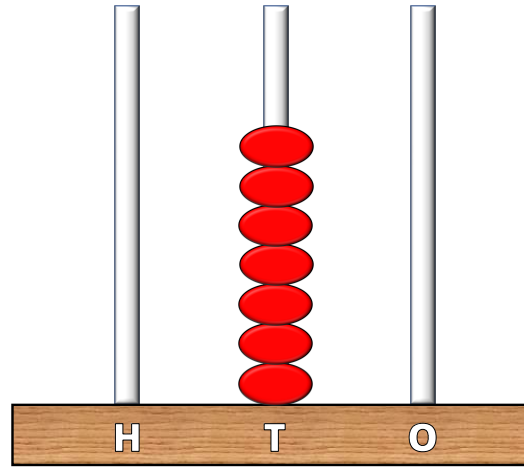
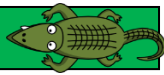

10x Representation Cards

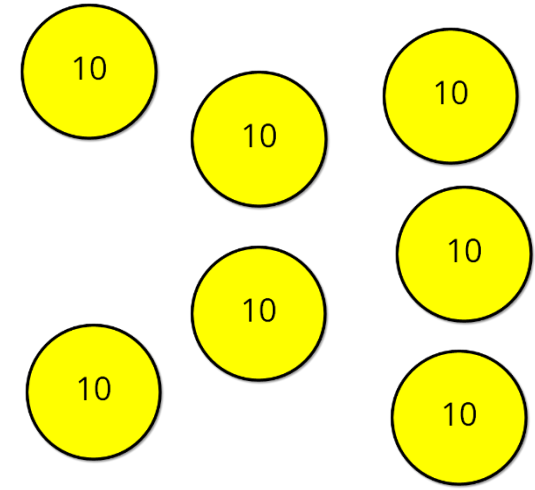
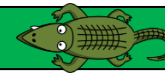

10x Representation Cards



7 multiplied
by 10

10x Representation Cards

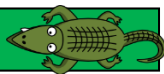

70

10x Representation Cards

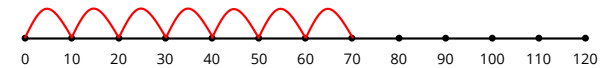
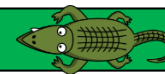

10x Representation Cards



$$8 \times 10$$

10x Representation Cards

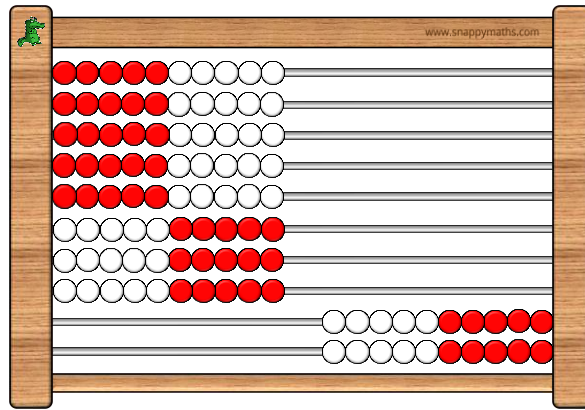
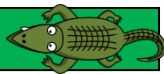

10x Representation Cards

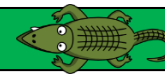

10x Representation Cards

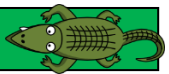

$$10+10+10+10+10+10+10+10$$

10x Representation Cards

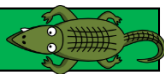

80

10x Representation Cards

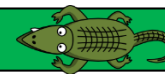

The product of 8 and 10.

10x Representation Cards

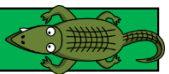

$$9 \times 10$$

10x Representation Cards

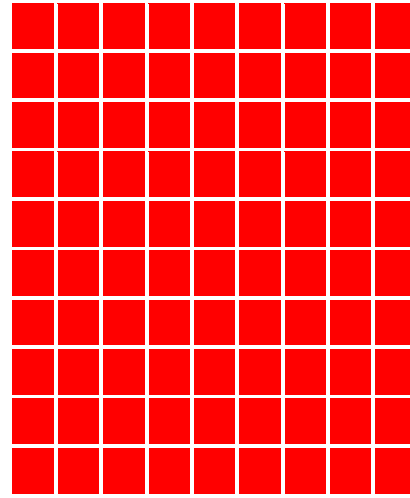
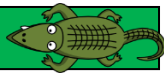

10x Representation Cards

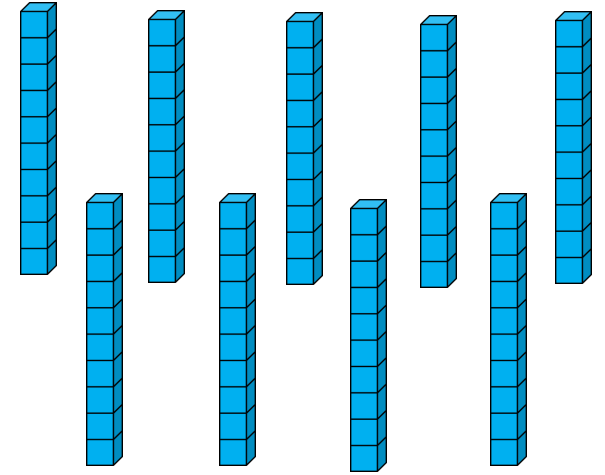
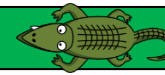

10x Representation Cards



$$10 \times 9$$

10x Representation Cards

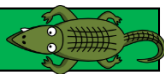

$$90$$

10x Representation Cards

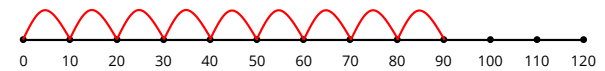
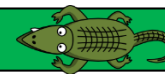

10x Representation Cards



$$10 \times 10$$

10x Representation Cards

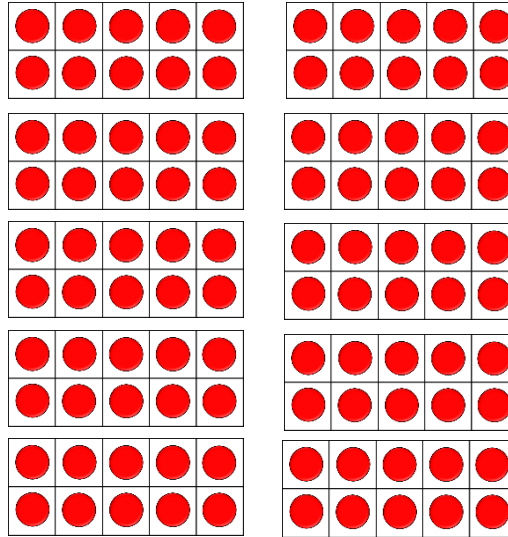
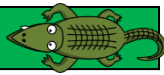

10x Representation Cards

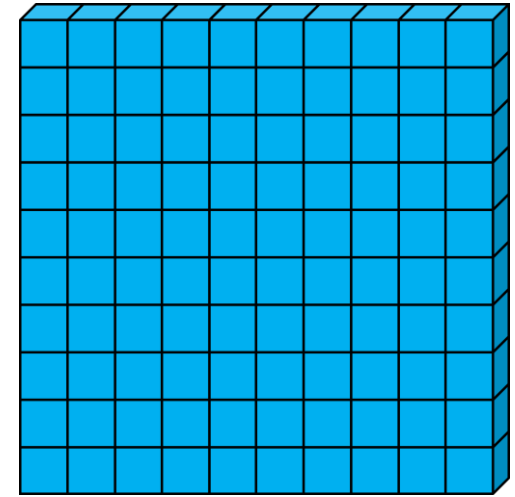
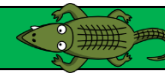

10x Representation Cards



10 multiplied
by 10

10x Representation Cards

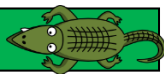

100

10x Representation Cards

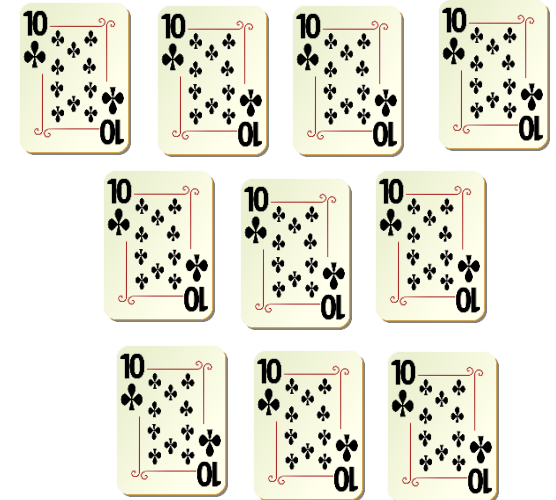
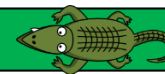

10x Representation Cards



$$11 \times 10$$

10x Representation Cards

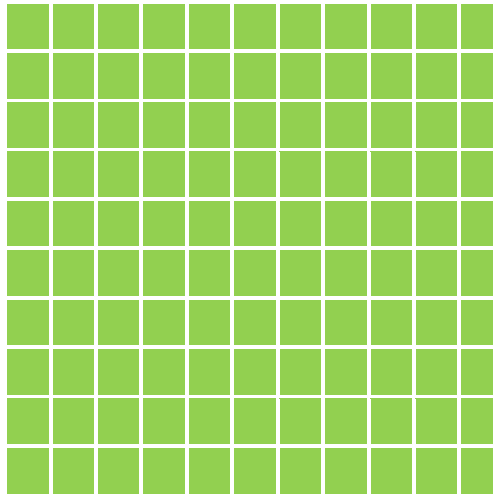
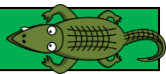

10x Representation Cards

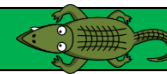

$$10 \times 11$$

10x Representation Cards



11 groups of
10

10x Representation Cards

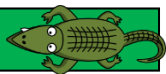

110

10x Representation Cards

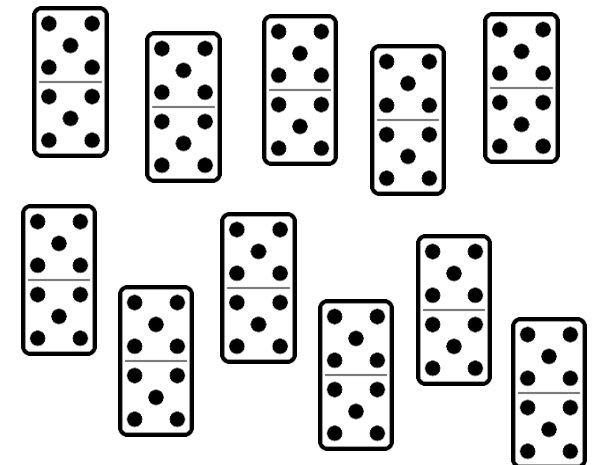
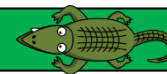

10x Representation Cards



$$12 \times 10$$

10x Representation Cards

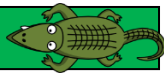

The product of
10 and 12.

10x Representation Cards

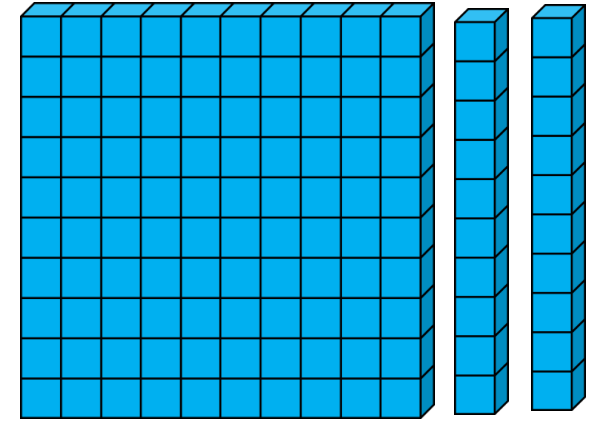
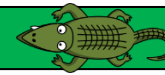

10x Representation Cards



$$10+10+10+10+10+10+10+10+10+10+10+10$$

10x Representation Cards

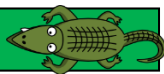

120

10x Representation Cards

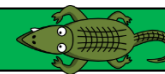

10x Representation Cards

